

Contents:

Model Selection	2
Calibration	2
Failsafe Setup	3
Automatic Mode Selection	4
Mechanical Reference	6
Keypad Button Reference	8













For further technical reference or calibration of units running version 2.X [click here](#) for the full technical guide

For questions or help contact your local sales rep or reach out to us at:

314-432-3282
sales@update-systems.com
joe@update-systems.com

Model Selection

For new XCTRL modules, select the model by:

1. From the main screen press , , 
2. Press  to start Model Selection. Use  and  to set the Torque option for your actuator
3. Press  to move to Power Option. Use  and  to set the Power Option for your actuator
4. Press  to move to Backup Option. Use  and  to set the Backup Option for your actuator
5. Press  to save the options

Device Defaults

The SmartStep actuator ships with the following defaults:

Range: 0-90°

4-20mA calibrated with 20mA set as OPEN and 4mA set as CLOSED

Rotation Speed set to 70% of maximum



Calibration

Set up a new calibration:

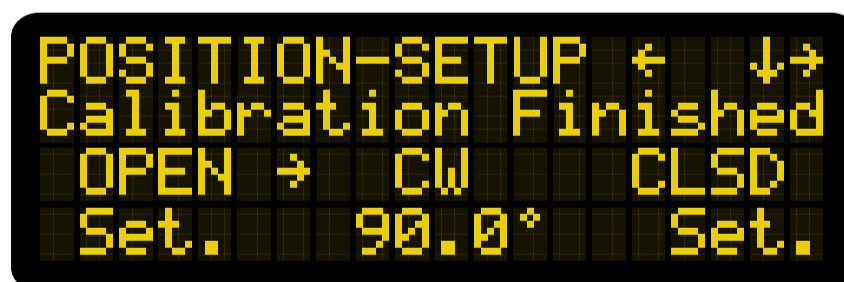

1. Perform **POSITION SETUP** of end points:

- a. Press  +  to see the following screen:



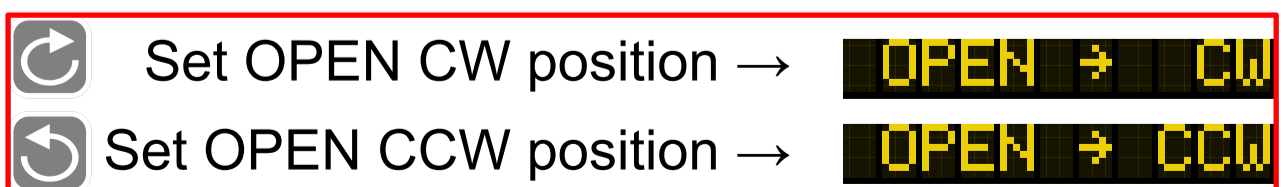





- b. Use the   buttons to set the direction the valve will move to get to the OPEN position



- c. Press  or  to clear the current setting of the end point that will be set first

Edit OPEN position → 
Edit CLOSED position → 

- d. Press  or  to move the valve in the direction of that end point. Hold down  or  to rotate at a faster speed. When in the appropriate position press  to save the position to memory.





Note: If setting a 90° Span you can automatically add 90° to the current end point after it's set. To do this, repeat step c for the second end point and then press  to add 90°.

- e. Repeat steps c and d for the other end point for an angle other than 90°

Failsafe Setup



1. Press the  key to continue on to FailSafe Setup. Press  to edit Failsafe Option

There are 4 options for Failsafe:

- i. CLOSE - Valve moves to closed position
 - i. OPEN - Valve moves to open position
 - ii. PERCENT OPEN - Valve moves to X percent of open position
 - iii. STAYPUT - Valve doesn't move at all
2. Use   to change value. If selecting Percent Open option: Use  to move to the numeric entry field.
3. Press  to store value

Automatic Mode Selection

To change the current AUTO mode of the actuator:

- Press  to cycle through the modes
- Press  to choose the proper mode for your application

4-20mA



IN + / IN - : Insert 4-20 mA or 0-10 V control signal into appropriate terminal. Valve moves to OPEN or CLOSED based on calibrated control signal values

OUT + / OUT - : 4-20 mA Feedback supplied for position reference. Default 4mA out is CLOSE position and 20mA out is OPEN position.

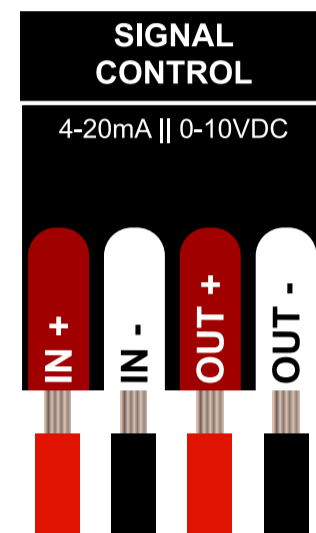
Wiring Example



MB-RTU

Standard MODBUS operation. Ensure Device ID, Baud Rate, and COM timeout are set up in the MBUS-RTU-SETUP screen. Accessed via  +  and then press  three times

Note: 12VDC Not needed for standard communication, only accessories

Wiring Example

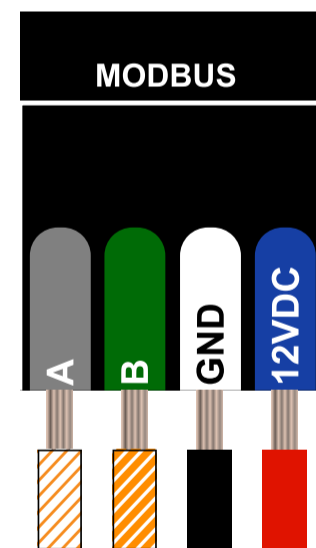

MB-TCP

MODBUS operation using TCP service. Ensure IP address, gateway, PORT, COM timeout, and whether DHCP will be used via MBUS-TCP-SETUP screen. Accessed by pressing the down arrow while on the MBUS-RTU-SETUP screen.

Wired With

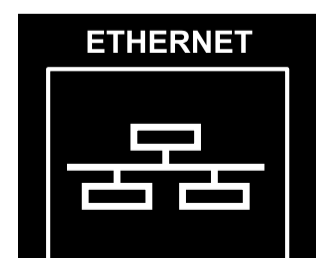

One-wire (OC1-WIRE)

Positive control wire inserted into open by default. When voltage is applied to positive control wire, valve moves to open position. Valve closes when signal is removed.

May be set up for closed. Option must be set in OC1-Wire setup screen and control wire must be inserted into CLOSE instead of OPEN.

Wiring Example

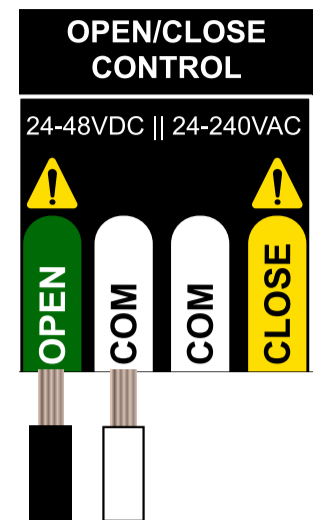

Two-wire (OC2-WIRE)

Neutral Wire Inserted in to COM; Positive Control Wires inserted into OPEN and CLOSE. When voltage is applied to Positive Control Wire the valve moves to programmed OPEN or CLOSE position. Otherwise remains stationary. If both inputs are removed, valve moves to set FAILSAFE position in OC2-Wire setup screen.

Wiring Example

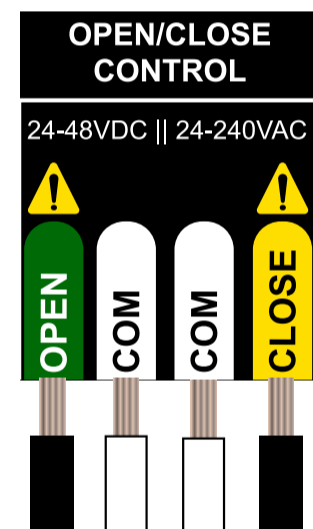

ON-OFF

Only available if SuperCap Installed

No additional wiring needed. If SuperCap installed option only needs enabled. Once enabled, power switch controls valve position. Valve will OPEN or CLOSE based on setting.

Mechanical Reference

Front

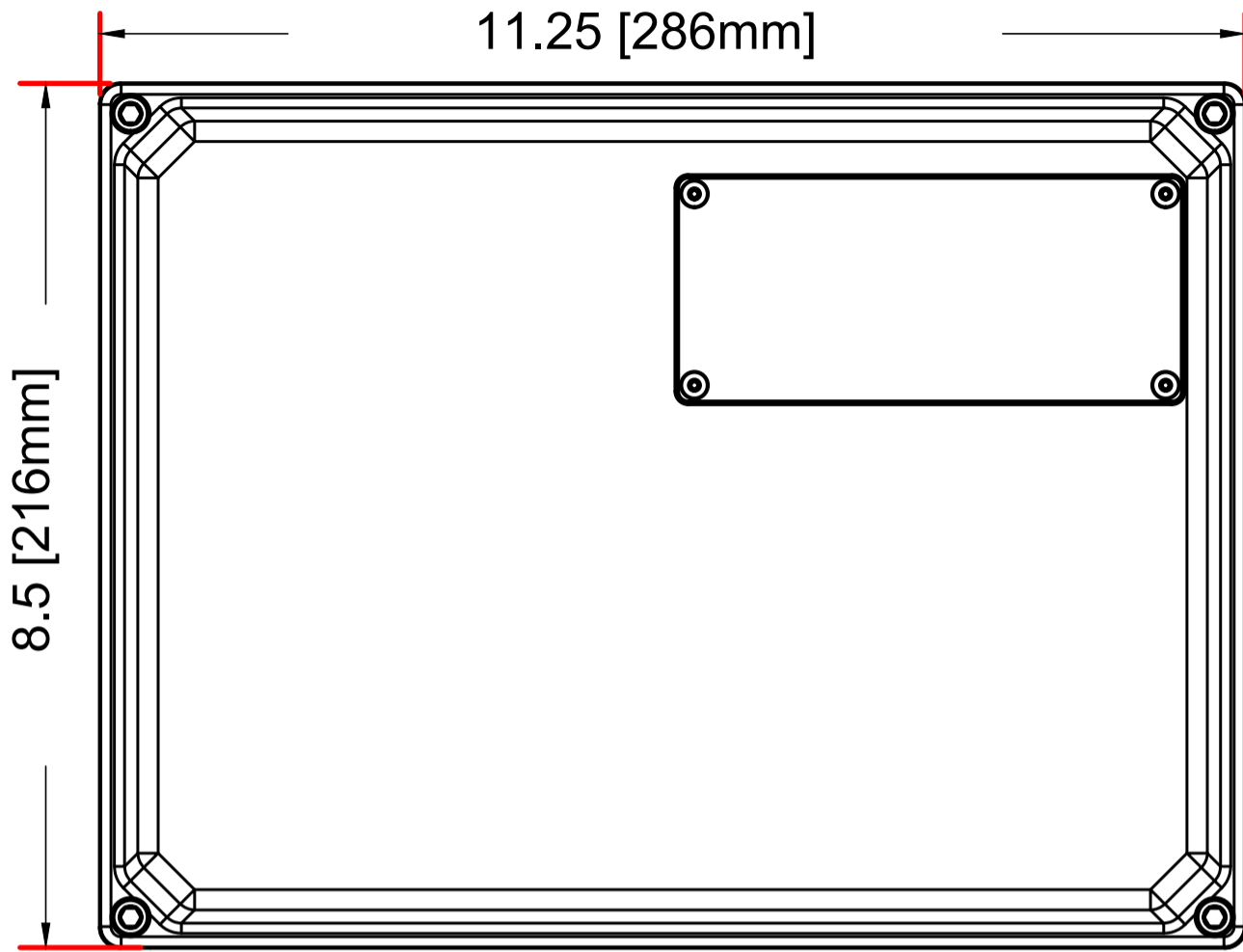

Rear

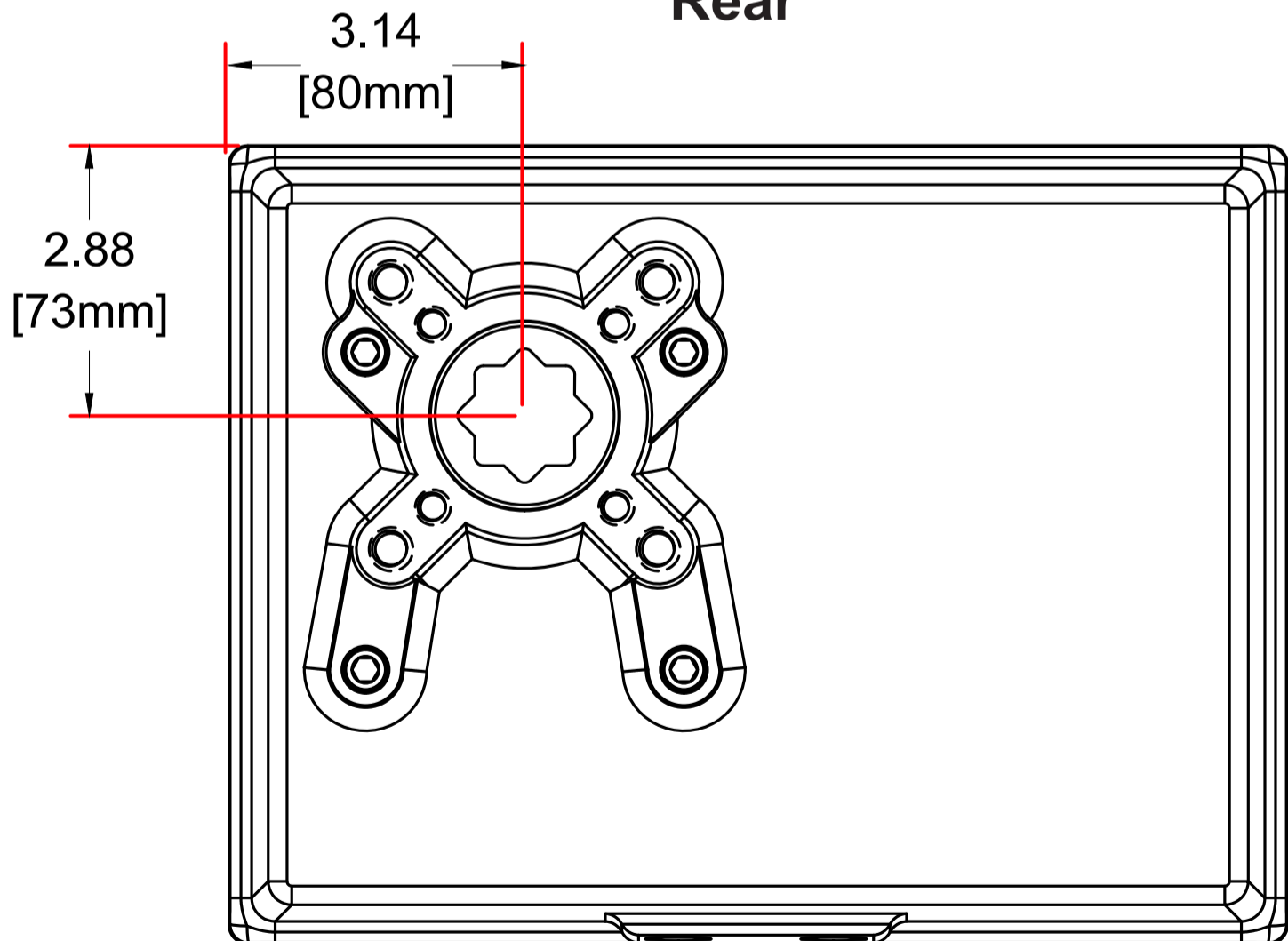

Bottom

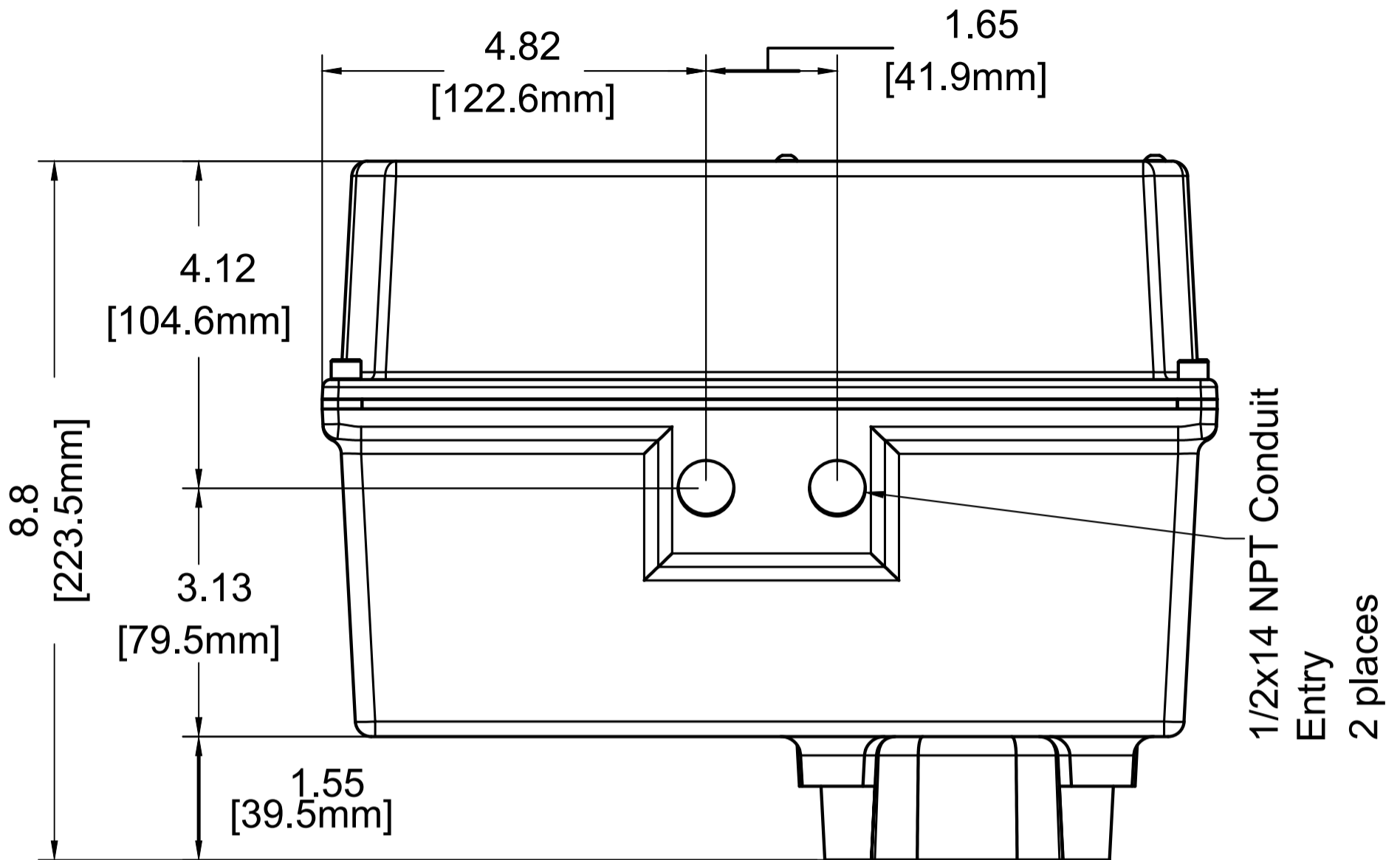





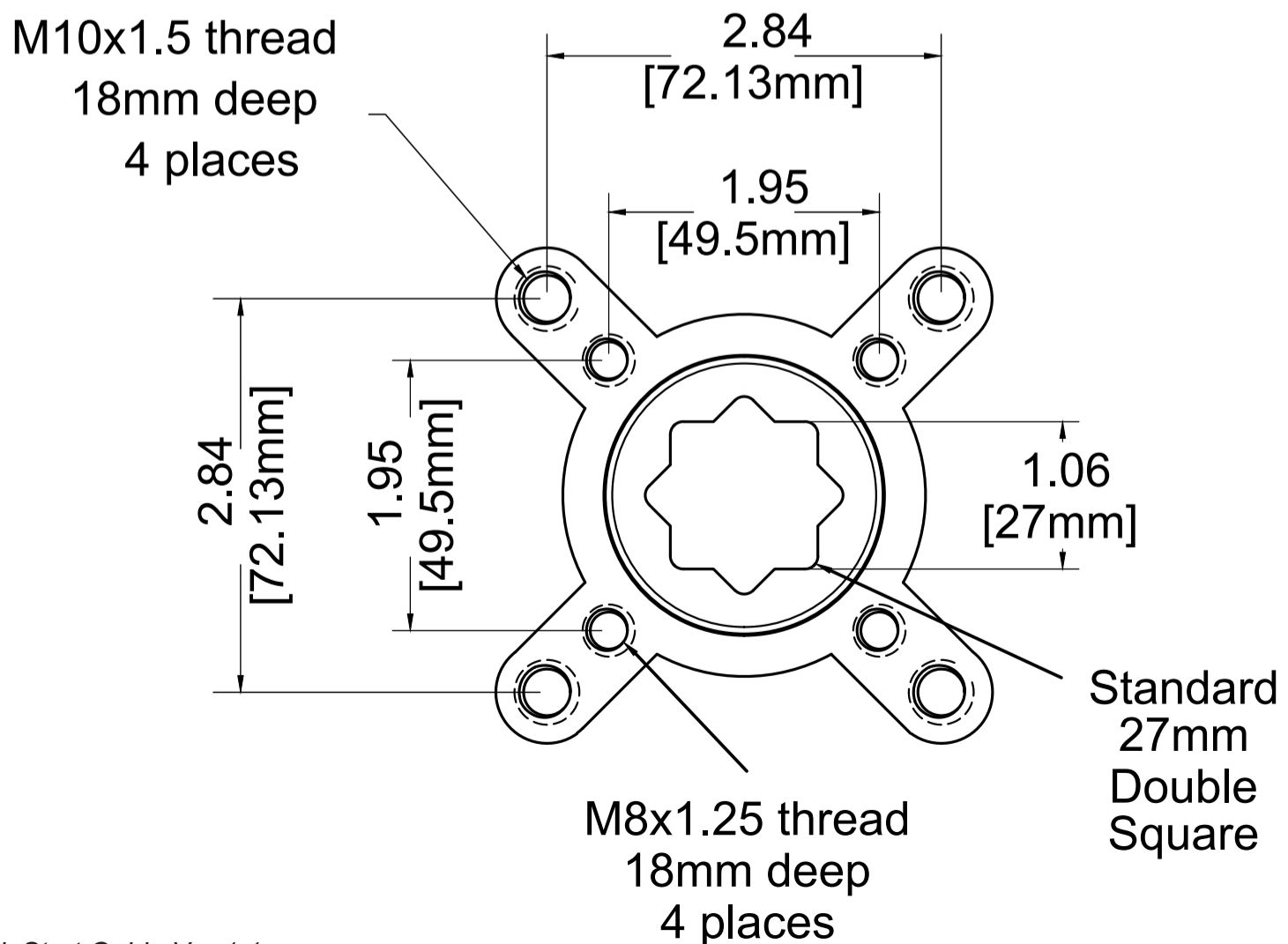









Note: add 3.5" [89mm] clearance for cover removal. Cover removal also requires 3/16" Allen Wrench

Mounting Detail



Keypad Button Reference

Buttons	
	Use to navigate menus and set values
	Store Values/Confirm
	Cancel Entry/Back out of Menu
	In calibration, press to set direction valve moves to open; Clockwise or Counter-Clockwise
	Manual Mode
	Move to calibrated open position Press to clear set point during calibration
	Move to calibrated closed position Press to clear set point during calibration
	Cycle between Automatic Modes (must press ENT to set after selecting proper mode)
Button Combinations	
Hold  + Press 	From Main Screen, enter Calibration Mode
Hold  + Press 	In Manual Mode, moves actuator to 100% open
Hold  + Press 	In Manual Mode, moves actuator to 100% closed